



TOM[®]

AUTOMATIC TANDEM TYING MACHINE

TOM



YAMADA KIKAI KOGYO CO., LTD.

YTC150-H2 YTC150-H **RAPID ONE** series

The highest capacity was realized by **TOM**® high speed machine series



YTC150-H2



YTC150-H

	YTC150-H2	YTC150-H
Capacity	Maximum 40 bundles/min. *	Maximum 35 bundles/min. *
Machine Dimension	L3,120 W3,390 H2,040 mm ~	L3,120 W3,390 H1,945 mm ~
Power Supply	8.0kVA (incl. control circuit)	6.5kVA (incl. control circuit)
Air Supply	1,200Nℓ/min (Equiv't to 11kW Compressor)	

* When the size is B = 600mm

Capacity shown is for tying of 10 corrugated boxes with Knot point changer

YTC150-H2

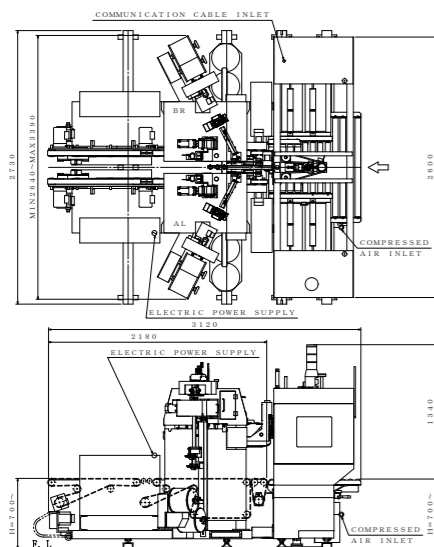

YTC150-H

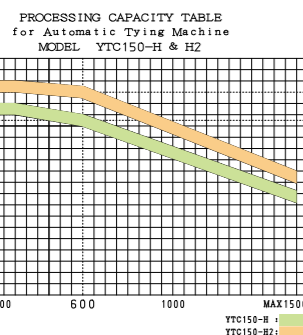
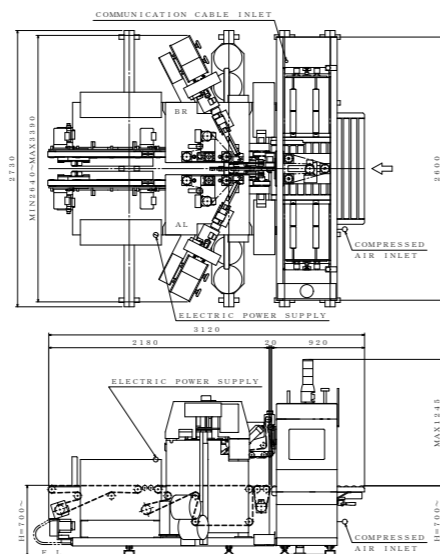

SIZES OF BUNDLES (YTC150-H2 / YTC150-H)

	Minimum	Maximum
A	300	1,500
B	200	1,500
C	40	370
D	210	960
E	45	270

Size C: 370(Before Compression)
40(After Compression)

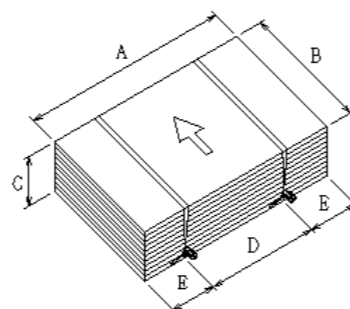

YTC145-D YTC145-I

YTC145-D

Compatible with high speed Folder Gluer machine.
This machine is available to data link with Folder Gluer or Palletizer.
Size changing work is eliminated.



YTC145-D

YTC145-I

Compatible with high speed Folder Gluer machine.
Size change is inching operation by push-button switch.



YTC145-I

(Machines shown in above photo are standard model.)

	YTC145-D	YTC145-I
Capacity	Maximum 30 bundles/min. *	Maximum 30 bundles/min. **
Machine Dimension	L3,120 W3,390 H1,945 mm ~	
Power Supply	3.0kVA (incl. control circuit)	
Air Supply	800Nℓ/min (Equiv't to 7.5kW Compressor)	

* When the size is B = 500mm

Capacity shown is for tying of 10 corrugated boxes with Knot point changer

** When the size is B = 500mm

Capacity shown is for tying of 10 corrugated boxes without Knot point changer

YTC145-D / YTC145-I

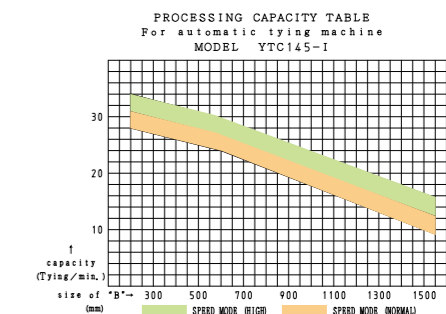
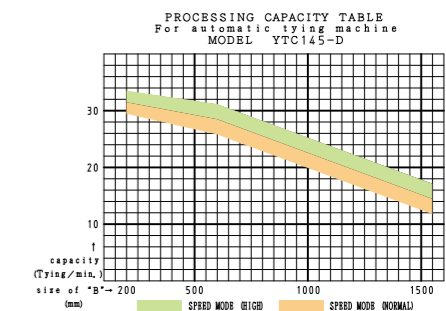
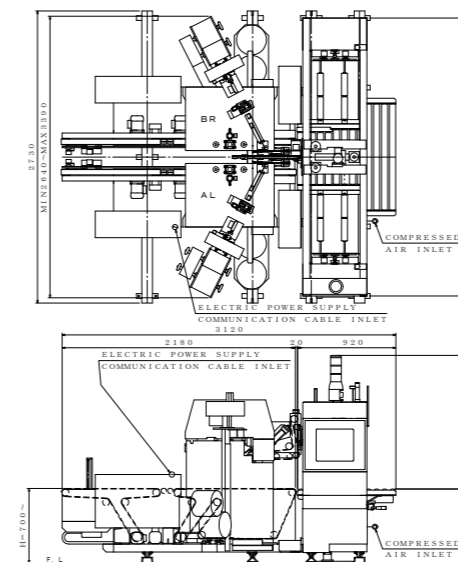

SIZES OF BUNDLES (YTC145-D / YTC145-I)

	Minimum	Maximum
A	300	1,500
B	200	1,500
C	40	370
D	210	960
E	45	270

Size C: 370(Before Compression)
40(After Compression)

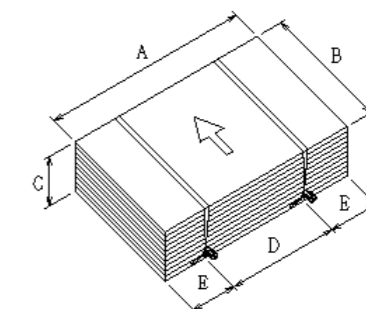

YTC145-ED YTC145-E

YTC145-ED
Compatible with middle speed Folder Gluer machine.
This machine is available to data link with Folder Gluer or Palletizer.
Size changing work is eliminated.

YTC145-E
Compatible with middle speed Folder Gluer machine.
Size change is inching operation by push-button switch.



YTC145-ED



YTC145-E

(Machines shown in above photo are standard model.)

	YTC145-ED	YTC145-E
Capacity	Maximum 25 bundles/min. *	
Machine Dimension	L3,120 W3,390 H1,775 mm ~	L3,120 W2,730 H1,715 mm ~
Power Supply	2.5kVA (incl. control circuit)	
Air Supply	600Nℓ/min (Equiv't to 5.5kW Compressor)	

* When the size is B = 300mm

Capacity shown is for tying of 10 corrugated boxes without Knot point changer

YTC145-ED

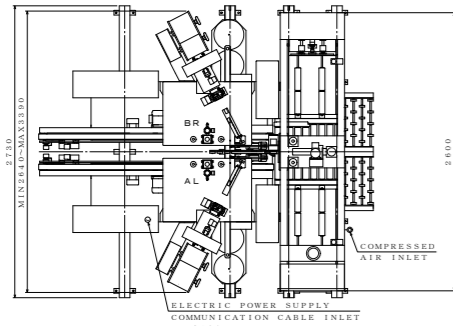

YTC145-E

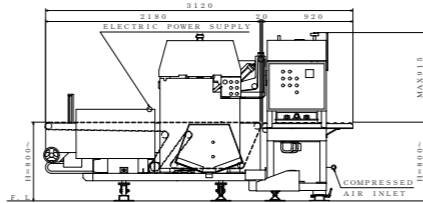
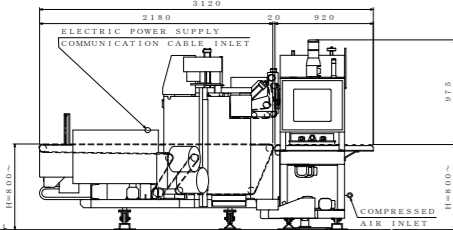
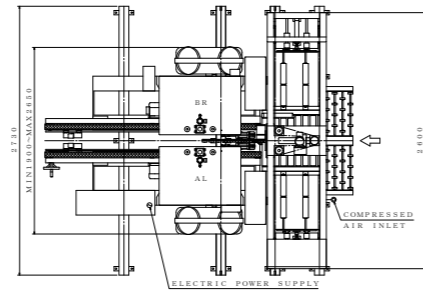

PROCESSING CAPACITY TABLE for Automatic Tying Machine MODEL YTC145-E&ED

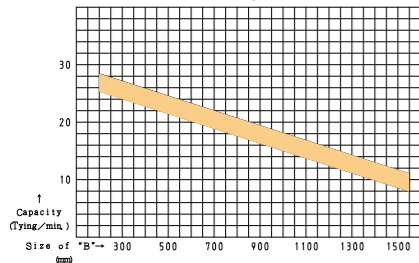

SIZES OF BUNDLES (YTC145-ED / YTC145-E)

	Minimum	Maximum
A	300	1,500
B	200	1,500
C	40	340
D	210	960
E	45	270

Size C: 340(Before Compression)
40(After Compression)

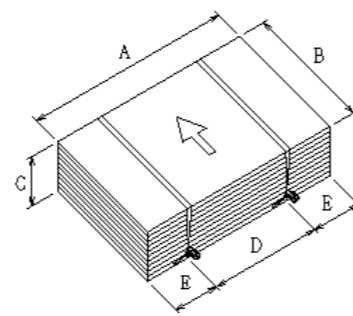

YTC145-ND

YTC145-ND Compatible with die cut sheet (not quadrangle sheet).

	YTC145-ND
Capacity	Maximum 20 bundles/min. *
Machine Dimension	L3,220 W3,490 H1,970 mm ~
Power Supply	3.5kVA (incl. control circuit)
Air Supply	600Nℓ/min (Equiv't to 5.5kW Compressor)

* When the size is B = 500mm

Capacity shown is for tying of 10 corrugated boxes with Knot point changer

YTC145-ND

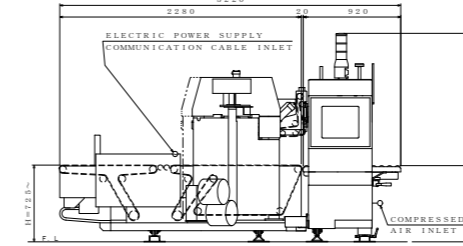
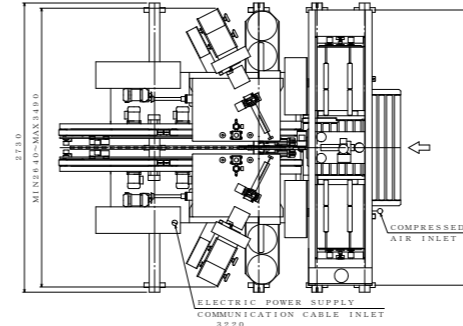

PROCESSING CAPACITY TABLE for Automatic Tying Machine MODEL YTC145-ND

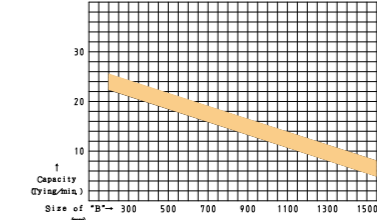

SIZES OF BUNDLES

	Minimum	Maximum
A	300	1,500
B	250	1,500
C	40	370
D	210	960
E	45	270
F	85	-
G	-	100

Size C: 370(Before Compression)
40(After Compression)

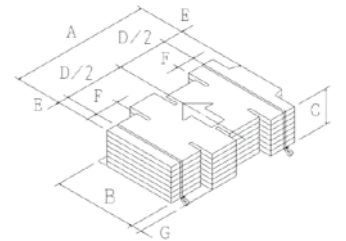

YTC180-E

YTC180-E Compatible with large size corrugated sheet.

	YTC180-E
Capacity	Maximum 25 bundles/min. *
Machine Dimension	L3,470 W2,730 H1,715 mm ~
Power Supply	2.5kVA (incl. control circuit)
Air Supply	600Nℓ/min (Equiv't to 5.5kW Compressor)

* When the size is B = 300mm

Capacity shown is for tying of 10 corrugated boxes without Knot point changer

YTC180-E

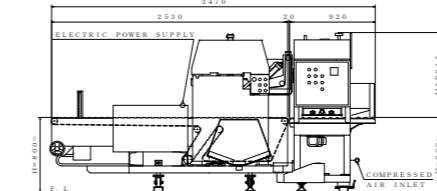
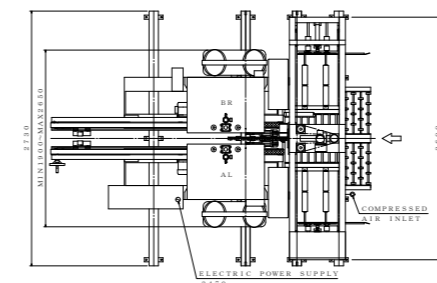

PROCESSING CAPACITY TABLE for Automatic Tying Machine MODEL YTC180-E

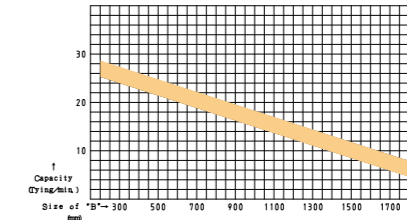

SIZES OF BUNDLES

	Minimum	Maximum
A	300	1,500
B	200	1,800
C	40	340
D	210	960
E	45	270

Size C: 340(Before Compression)
40(After Compression)

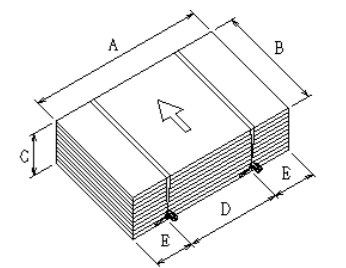

We will propose a larger size according to your needs.

Knot Point Changer (standard equipment)

Knot point is moved to the side.

When they are piled up, that is not damaged.

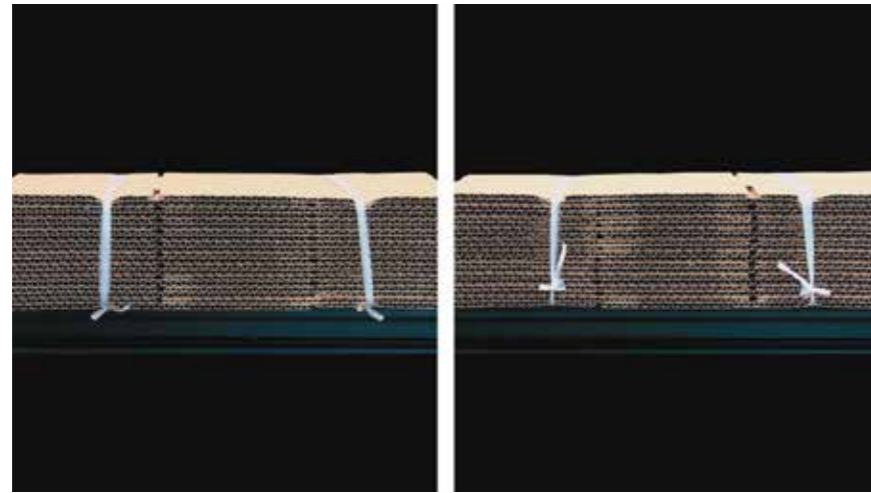

UNUSED

USED

Twine Unfolding Device (option)

With twine which has been unfolded as shown in the photo prevents inserting a twine into the base liner as breaking the surface of the corrugated cardboard.

Therefore, this function which has been equipped prevent to come to the core base as breaking the base liner of corrugated cardboard by winding a twine.



UNUSED

USED

- ※Do not use other twines except P-50 twine.
- ※There are twines which can't use by a quality in twine P-50.
- ※Regarding the twine which is used, please consult to us.
- ※Must stop the machine when replacing the twine roll.

Data Link (standard equipment for YTC150-H2, -H, YTC145-D, -ED, -ND)

The folder gluer (FFG) supplies size data, the tying machine can be programmed to change sizes automatically.

The process of changing sizes takes about one minutes.

To reduce the operator's burden and improve production efficiency

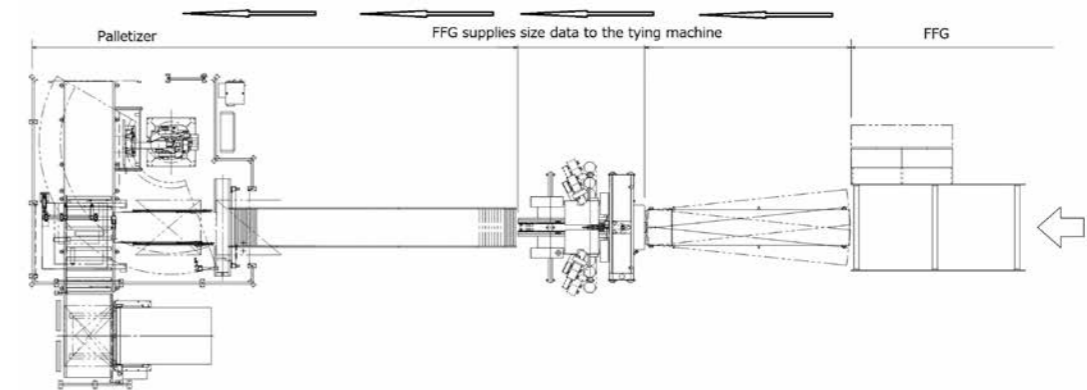

Quantity Checker and Discharge Conveyor (option)

To check the height of bundled cardboard if abnormality in number of bundled corrugated cardboard is found, it is removed by discharge conveyor.

This function is available to prevent stop in the production line.

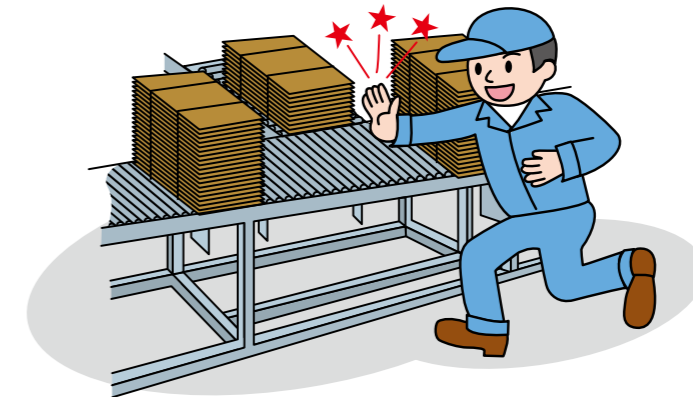

Conceptual Diagram

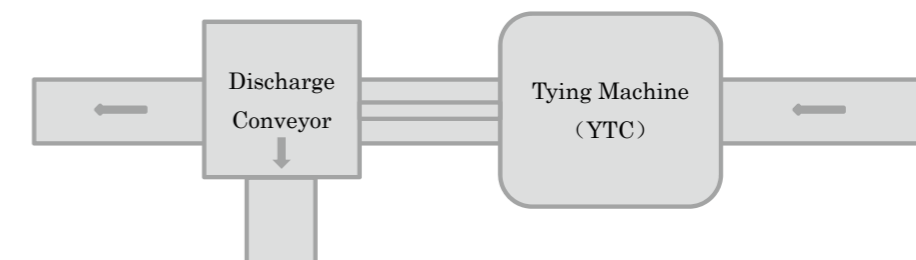

Max. Tying Range Chart

How to use the Chart for Y80, for example.

The curve of Y80 shows that Max. Width 810mm corresponds to Max. height 620mm

Max. Height 710mm corresponds to Max. Width 720mm.

Please contact us for further details of tying range.

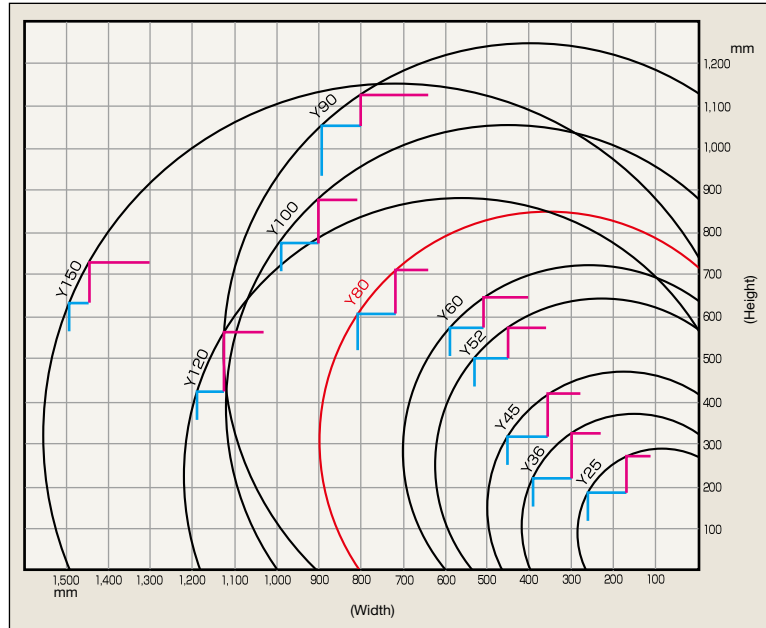

Unit : mm			Unit : mm		
Model	Max.Width	Height	Model	Width	Max.Height
Y25	260	190	Y25	160	260
Y36	380	230	Y36	300	320
Y45	460	320	Y45	360	420
Y52	530	500	Y52	450	560
Y60	610	570	Y60	510	650
Y80	810	620	Y80	720	710
Y90	900	1,050	Y90	800	1,130
Y100	1,000	770	Y100	900	880
Y120	1,180	420	Y120	1,120	560
Y150	1,480	630	Y150	1,430	740

◆ Please use the “Max. Tying Range Chart” for Model selection.



Model **Y60**

- Department Store/Supermarket
- Shopping Street
- Various Manufacturers

Unit mm

Height	Width	Length	Weight (kg)	Motor (W)	Loose Table Depth	Min. Tying Range
1,600	1,060	980	160	1:100V 300 3:200V 400	250	100x100



Model **Y80**

- Paper Containers/Cardboard Industries
- Department Store/Supermarket
- Various Manufacturers

Unit mm

Height	Width	Length	Weight (kg)	Motor (W)	Loose Table Depth	Min. Tying Range
1,660	1,350	1,270	230	1:100V 400 3:200V 400	340	200x200



Model **Y100**

- Paper Containers/Cardboard Industries
- Various Manufacturers

Unit mm

Height	Width	Length	Weight (kg)	Motor (W)	Loose Table Depth	Min. Tying Range
1,850	1,590	1,270	255	1:100V 400 3:200V 400	340	200x200

Power supply voltage can be selected per User's request.

YAMADA KIKAI KOGYO CO., LTD.

URL: <http://www.tom-yamada.co.jp/>
 E-mail : sales@tom-yamada.co.jp
 Head Office : 3-1, Osaku 2-Chome, Sakura City, Chiba, Japan.
 Export Sec. : 3-1, Osaku 2-Chome, Sakura City, Chiba, Japan.
 TEL : 043-498-1000
 FAX : 043-498-0106



◆ Distributor